

# PRODUCT SHEET

## Description:

Cam Lock 1916, 90DG, SS Cap+Core, Cam A51, Box Packing, CK SISO, Cranked 5mm, W/2  
Transparent PVC Washers,, 480 Small Boxes Pr. Export Carton, 480 Different Key Codes, pr. Carton

## Item number:

14.04.471-0

Units	Box	Carton	HS Code	Barcode
Pcs.	12	240	8301300000	
				5704866041683

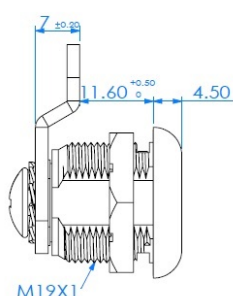
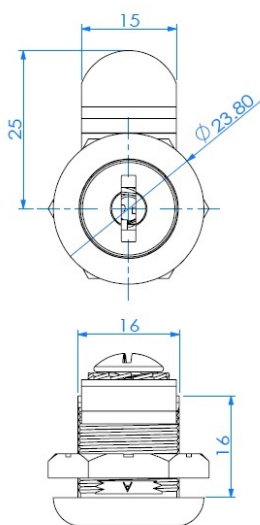
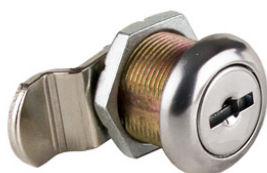

Installation diagram

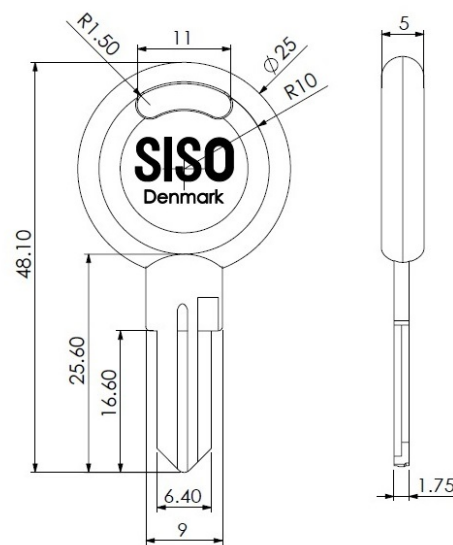
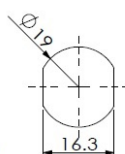
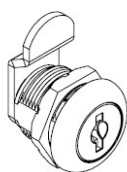
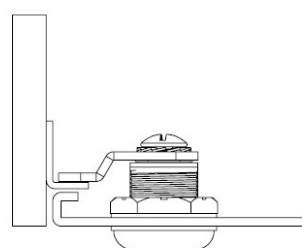

## SISO A/S

Mileparken 11  
DK-2740 Skovlunde  
Denmark  
VAT: DK 24786013

Phone +45 45 830 900

[www.siso.dk](http://www.siso.dk)  
[siso@siso.dk](mailto:siso@siso.dk)

Danske Bank  
Nytorv Branch  
Copenhagen  
SWIFT: DABADKKK

Account no.  
4180 3112 112936  
IBAN Account  
DK7230003112112936