

How to decode the forgot combination ?

- Master Key operation may be used at any time to open a lock in an emergency.

1. Insert and turn the Master Key clockwise 180 degree to open the door if necessary (Fig.A). Make sure to turn the key counter clockwise 180 degree to withdraw the Master Key.
2. Push the Decode Lever all the way while rotating each dial from left to right until it stops or there is a "click" sound (Fig. B).
3. Release the Decode Lever. You can now keep using the retrieved combinations or reset your new desired codes (Fig. C).

Fig.A

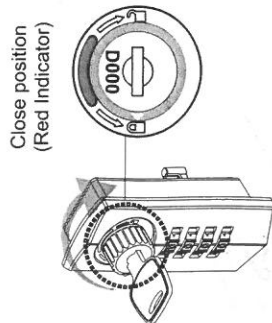

Fig.B

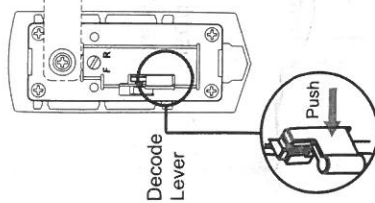
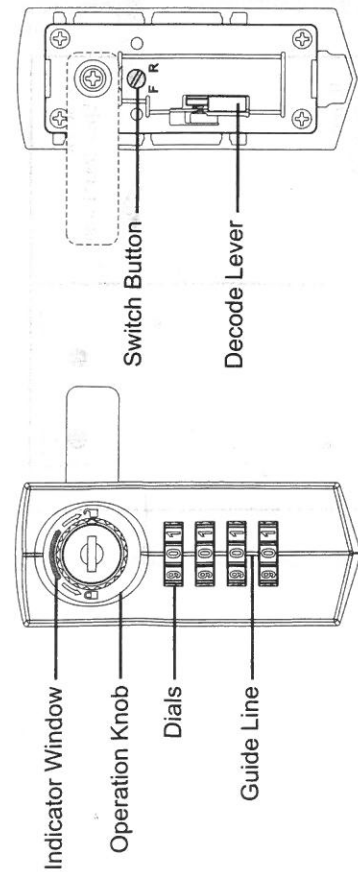
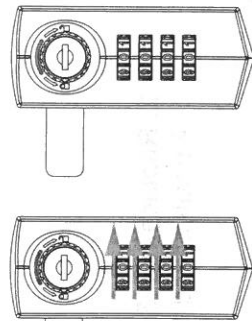

Fig.C



FIXED VERSION

In fixed combination mode, the lock is continually opened and closed with the same custom combination that was set.

1. Turn the Operation Knob clockwise 180 degree to the open position. The indicator in the window will turn to green (Fig. D).
2. Turn the Switch Button on the back of the lock to the "Reset" position (Fig. E). Now, the lock is set to continuously open using the desired fixed combination (Fig. F).
3. Set the desired custom combination.
4. Return the Switch Button back to "Fix" position.

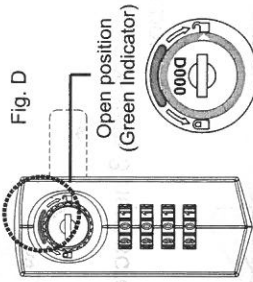

Fig. E

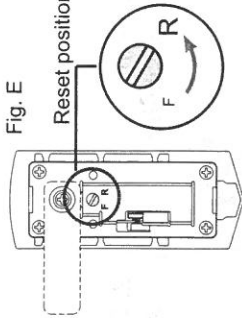
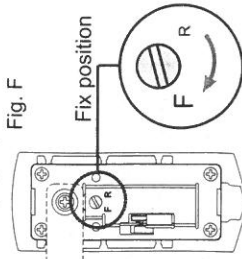

Fig. F



OPEN-RESET VERSION

In the open-reset combination mode, the combination may be changed after each time the lock is opened.

1. Turn the Operation Knob clockwise 180 degree to the open position. The indicator in the window will turn to green (Fig. G).
2. Turn the Switch Button on the back of the lock to the "Reset" position. Leave the button in this position (Fig. H).
3. Now, the combination can be resettable before turning the Operation Knob to the locked position (red indicator). Set your own desired combination before closing the door and remember your reset code (Fig. I).

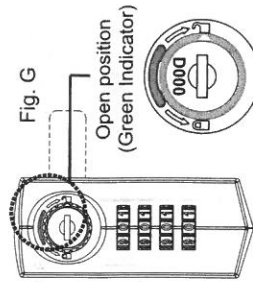

Fig. H

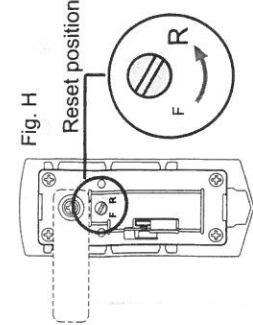
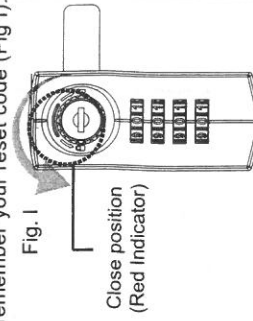

Fig. I



- Close the door and scramble the dials before leaving. Now your cabinet is locked.
- Always keep your secret combinations in a safe and accessible place for future reference.

Installation

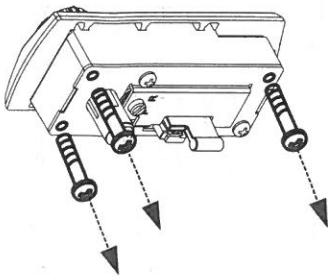

Panel thickness: 16~35mm

1. Remove the original screws (3pcs, screw position shown as below).

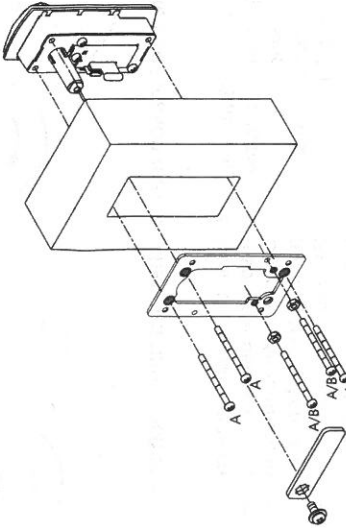

2. Replace with 5 new screws in A position and 2 nuts in B position.

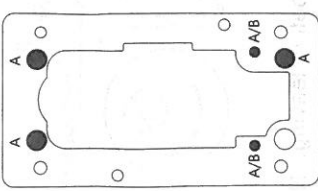

<p>A: screw 5pcs (M3*38mm)</p> 	<p>Remarks: Please tailor the length of screw according to the panel thickness (16~35mm)</p>	<p>B: nut 2pcs (M3)</p> 	 <p>Back plate:1pcs</p>
--	--	---	--

Panel thickness: 15mm

1. Remove the original screws (3pcs, screw position shown as below).

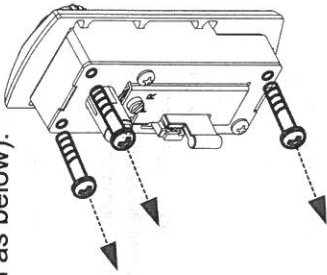

2. Replace with 3 new screws in A position.

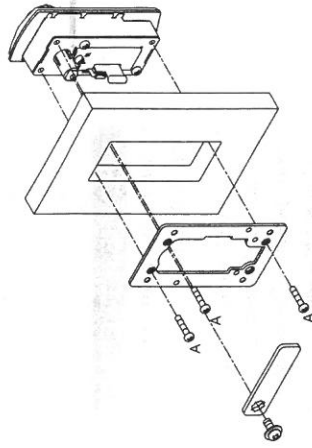

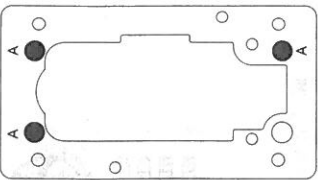
<p>A: screw 3pcs (M3*15mm)</p> 	 <p>Back Plate:1pcs</p>
--	--

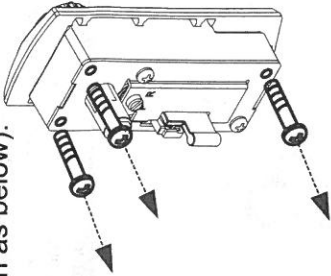

Panel thickness: 10~14mm

1. Remove the original screws (3pcs, screw position shown as below).

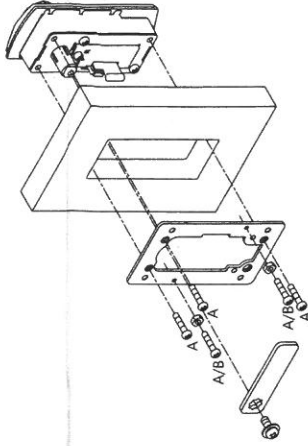

2. Replace with 5 new screws in A position and 2 nuts in B position.

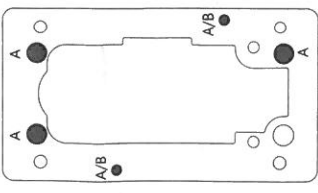

<p>A: screw 5pcs (M3*15mm)</p> 	<p>B: nut 2pcs (M3)</p> 	 <p>Back plate:1pcs</p>
--	---	--

Panel thickness: 1mm

No need of removing any original screws. Just follow the instruction below.

